

LX *flarm* Red Box

HW Version 2

with optionally SD-card interface IGC approved flight recorder and ENL sensor
User manual



1	Introduction	3
1.1.1	Basic configuration.....	3
1.1.2	SD card configuration	4
1.1.3	IGC approved flight recorder and ENL.....	4
2	Technical data	4
2.1	Part list.....	5
2.1.1	Flarm Red Box	5
3	Operation.....	5
3.1	Flarm external display	5
3.1.1	Display settings	7
3.2	Using of LX Flarm Colour graphic displays.....	8
3.3	Update of Red Box settings	8
4	Firmware update.....	9
4.1	Cable configurations	9
4.1.1	Colibri power and data adapter (COL-AC-PC).....	9
4.1.2	LX Flarm update cable	9
4.2	The procedure:	10
5	Installation.....	11
5.1	Display installation	11
5.2	Power	11
5.3	RF antenna installation	11
5.4	GPS antenna installation.....	12
5.5	Final check.....	12
6	SD card and Flight recorder option	13
6.1	Firmware update after using of SD card	13
7	Limitations	14
8	IGC approved flight reordered management	14
8.1	Task declaration.....	14
8.1.1	Task declaration via PDA/PNA.....	14
8.1.2	Downloading of flights.....	14
8.1.2.1	Using of SD card	14
8.1.2.2	Using of Flarm tool.....	15
9	Flarm configuration.....	15

1 Introduction

Flarm is a collision avoidance system developed by Flarm Technologies from Switzerland. LX Navigation and Flarm Technologies signed a contract under which LX Navigation got rights to integrate Flarm technology into LX Navigation products.

A Flarm module consists of following main parts.

- GPS receiver, plus GPS antenna
- Microcontroller unit
- Radio Transceiver
- Pressure altimeter
- Flarm external indicator*

*Flarm LED indicator (standard solution) and Flarm Colour graphic display may be used without any limitations.

The GPS receiver defines position of the glider, the microcontroller is responsible for collision prediction calculations and the transceiver is sending and receiving data.

LX Flarm Red Box comes in four variants. The basic configuration can be extended to following options:

- with SD card option, not approved flight recorder and FW upgrade possibility by SD card
- With SD card, approved flight recorder and FW upgrade possibility by SD card
- With SD card, approved flight recorder, FW upgrade possibility by SD card and ENL sensor

1.1.1 Basic configuration

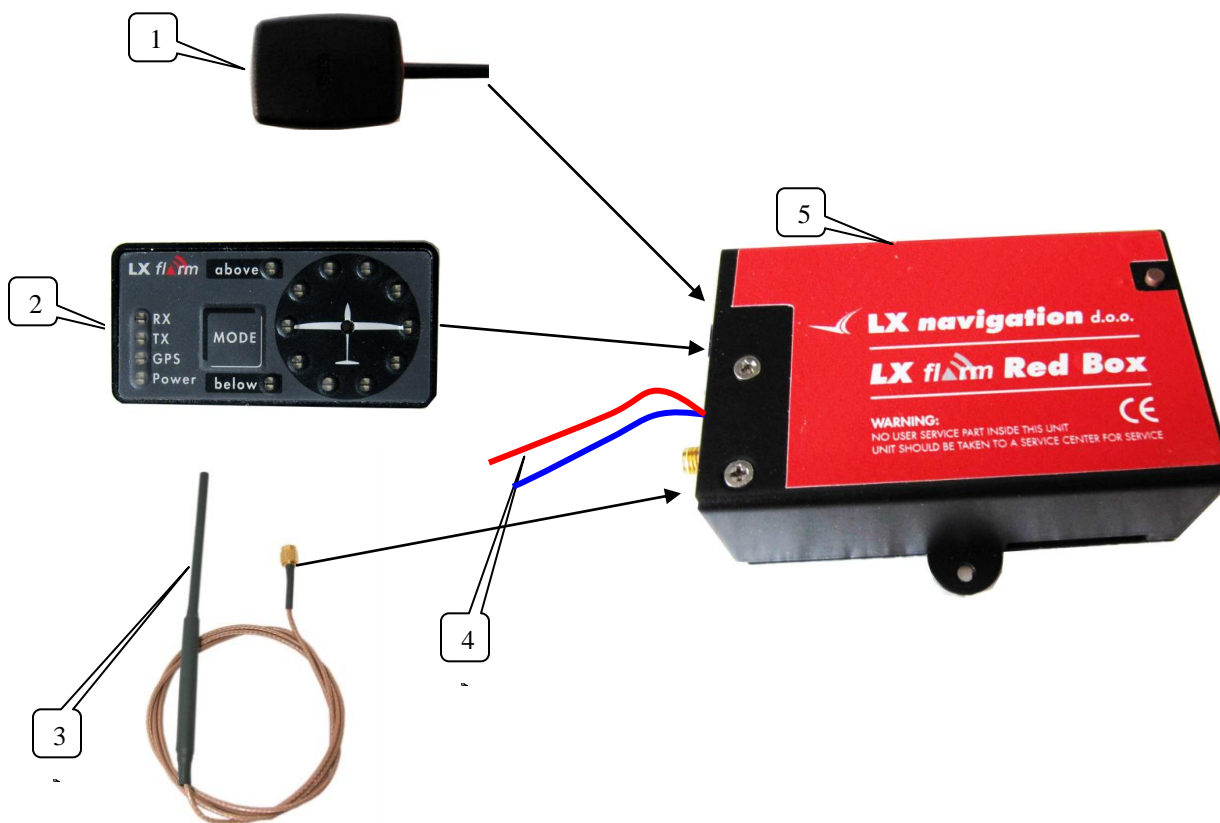

1 GPS antenna, **2** Flarm display, **3** RF antenna, **4** power lines, **5** Flarm box

1.1.2 SD card configuration

SD card reader is added to the system as a fix wired device. The unit has also an internal SD card slot and this could be also used for SD data transfer. It is also possible to cut the original SD card reader cable and to use **internal variant**.

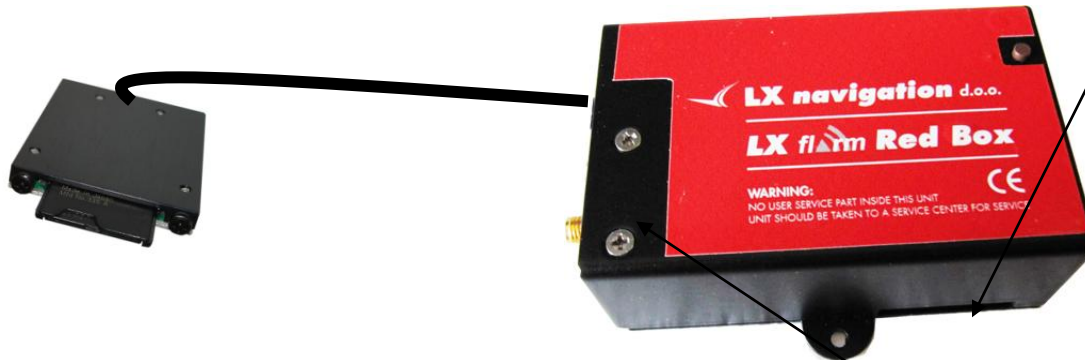

Note!

Never insert two SD cards into SD card readers at the same time.

1.1.3 IGC approved flight recorder and ENL

IGC approved units have HW configuration as mentioned in 1.1.2 and 1.1.1. The only visible sign is a **security label** which prevents not authorized opening of the unit.

ENL (Engine noise Sensor) option can be added to any unit which has IGC option, the upgrade is possible at any time. The option is marked with a label **ENL Inside**. Otherwise there is no HW characteristics.

2 Technical data

- Dimensions: 84x53x30 mm aluminum housing
- Weight: approximately 150 gr.
- GPS connector: fix wired
- RF connector: SMA female
- RF range: max. 5 km, depends on antenna installation
- Data interface 6P telephone type, for display and FW update
- Power : 8-16 V DC ,consumption ca. 60 mA by 12V DC
- Pin 6 power input (8-16V), 4 and 1 GND (near to RF connector), 2 data in, 3 data out, 5 power for external display

2.1 Part list

2.1.1 Flarm Red Box

- Flarm red Box unit
- RF antenna
- GPS antenna
- Flarm External display with cable
- Options

3 Operation

The unit will run immediately after power will be applied. With GPS antenna connected and visible satellites about three minutes will take to be operable. There are no commands or status indicators on the unit. All important statuses are be readable on External display, also all inputs will be done this way.

3.1 Flarm external display

The unit consists of a 50x20 mm flat housing which has one push button and 16 LED's. A 6P telephone type connector connects External display with Flarm unit. Each LED position is equipped with two LEDs, one red and one green.

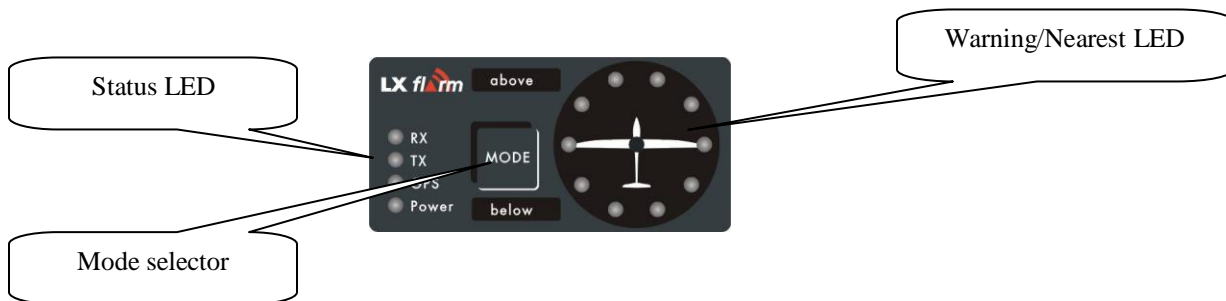

- 10 radial positioned LED's, defines **direction to** the near glider (top LED active means frontal collision risk)
- 2 additionally red light emitting diodes marked like **above** and **below** informs about vertical position of the glider, which is close.
- **Mode** button is used to control the unit, see table below
- 5 status LED's.

Description of LED statuses:

- **Power red flashing**, no data from Flarm
- **Power green** data received
- **GPS red** GPS BAD, **GPS green** GPS OK/3D
- **Tx green** flashing, data sent
- **Rx green**, minimum one glider in range
- **Green circular**, indication of near gliders
- **Red circular flashing**, collision warning
- **Above below green** by near
- **Above below red** by warning
- **018°, 054°, 324° and 288°** green and red flashing, obstacles in front

The external display has two modes of operation:

- **WARNING Mode** will activate a red blinking diode, if another glider equipped with Flarm will be close and a prediction for a **collision** risk will exist. An audio warning will be also executed. Higher collision risk will increase blinking frequency and the same is with audio. The warnings are classified into three levels (See Flarm manual for details)

- First level approximately **18 seconds** before predicted collision
- Second level approximately **13 seconds** before predicted collision
- Third level approximately **8 seconds** before predicted collision

Note!

Warning mode will show only gliders who caused a collision risk, other gliders won't be detected.

- **NEAREST Mode** will show the direction to the nearest glider (always green) which position is inside of radio range. **One** green LED will light **permanently** and there will be **no audio**. The unit will change over to Warning Mode **automatically, if warning** criteria will be fulfilled and will continue in NEAREST after collision risk will disappear.

Note!

To change mode of operation (nearest to warning and vice versa) press **MODE** button for approximately **2 seconds**. If the radial LED's will run from top toward bottom means change over to NEAREST and vice versa. After new power on, nearest will be set.

Note!

The external displays produced by LX Navigation will change over to **Demo mode** after MODE button will be short pressed 10 times. Nearest mode and all possible warnings will be displayed. To change over back to normal operation switch the unit **off**.

- Pressing of MODE selector continuously for approximately **4 seconds will deactivate** Flarm external display for next 5 minutes, no **warnings** and no **near** information will be displayed during this period. A very typical situation only Power LED on, will characterize this status.

- **Obstacles.** Flarm electronic is capable to store **coordinates of obstacles**, which could cause a collision during flight. This data is available on www.flarm.com, use Flarm tools to update. The unit is factory loaded with actual obstacle database. An obstacle warning will be activated, if an obstacle is to be found in the front of the glider and a collision risk is predicted. After a low level warning has been activated two upper LEDs will be active (such a situation will never appear by glider collision risk). Medium and high risk will be indicated with more LED's active and more frequent audio signal.
- To change **audio warning volume** press short mode selector, each press will increase audio volume (three levels and mute available).

Note!

To change mode of operation press **MODE** button for approximately 2 seconds. If the radial LED's will run from top toward bottom means change over to NEAREST and vice versa. After each **new power on**, the unit will start in **Nearest** mode.

3.1.1 Display settings

Using of mode selector button is possible to adjust some parameters of the display (baudrate and hierarchy). **Disconnect** the unit, **press mode selector** and hold, **power on** and continue holding of mode selector for **about 4 seconds**. The display parameter indication will change (see table below) after each press on mode selector for approximately **2 seconds**. To change press mode short, the status will indicate circular **LED's**.

Parameter	LED	Green LED 018°	Green LED 054°	Green LED 090°	Green LED 126°	Green LED 162°	Green LED 198°
1.seat	Tx	PIC					
2.seat			PAX				
Baudrate	Tx+Rx	4800 bps	9600 bps	19200 bps	-----	38400 bps	57600 bps

Table of possible settings



Example (color doesn't matter)

If two units will work in parallel (double seater), one unit must be PIC (front seat) and another PAX.

Note!

Baud rate is factory set to **19200**. The display will not work if the baud rate will not match the master unit. A red flashing power diode will show this situation.

3.2 Using of LX Flarm Colour graphic displays

The display is 100% compatible to LX flarm RB and could be connected to Fl. Ext. display plug via standard cable delivered with the unit.

3.3 Update of Red Box settings

It is obligatory that both units (Red Box and the display) have the same communication speed (**baud rate**). If there is any reason for another com speed, (using of Flarm as GPS source for other units...), the com speed of the Flarm unit can be any time adjusted after using of **Flarm tools**. Use option **Settings**. How to connect Flarm Red Box to PC see capture 4.

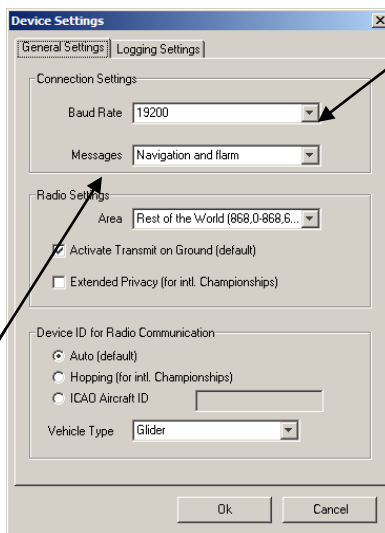

Note!

The option “**Navigation and Flarm**” means that the Flarm unit is sending Flarm and navigation data. This option is obligatory to be enabled, if the LX Flarm Red Box will be taken as GPS source for another navigation instrument PDA or will drive LX Colour graphic display.

If another navigation device for instance PDA is intended to be used, a splitter should be inserted. LX Navigation offers a wide range of splitters.

4 Firmware update

Flarm software expires and therefore periodically firmware upgrades are necessary. Flarm original tools should be used, available on www.flarm.com. A cable set isn't a part of delivery. Use IGC compatible cables, for instance Colibri/LX20 power and data adapter (**COL-AC-PC**).

Note!

Colibri power adapter will also power Red Box

4.1 Cable configurations

The cable connecting PC and Red Box should consist of 3 wires, two data wires and GND. There are many solutions which enables communication and consecutive firmware update. Some cable configurations are listed below.

4.1.1 Colibri power and data adapter (COL-AC-PC)

This cable set is a part of delivery of every Colibri unit and could be simple borrowed from some Colibri owner. The set can be also ordered at any time by LX Navigation. This is a completely plug and play solution which makes possible to arrange update without glider power, let say at your home. The set has an AC/DC converter and this also powers Red Box during the firmware update.



Important!

Keep Red Box power lines isolated during the update.

4.1.2 LX Flarm update cable

This cable is a part of delivery of every LX 7007 Flarm unit and can be also used for Red box update. In this case Red Box needs power via its power lines. The cable can be simple build by the Red Box owner or ordered by LX Navigation..

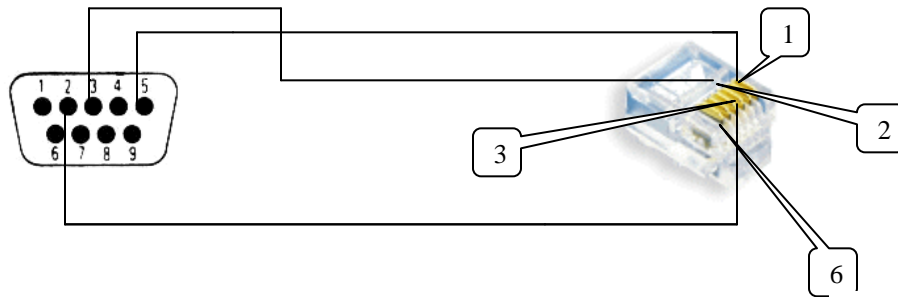

SUB D 9P	5	3	2
RJ 11 (6P)	1	2	3

4.2 The procedure:

- Run actual Flarm tool on PC
- Plug 6P RJ connector into Red box
- Power ON Red Box
- Wait (apr.30 seconds) until **Connect** status on tools will appear

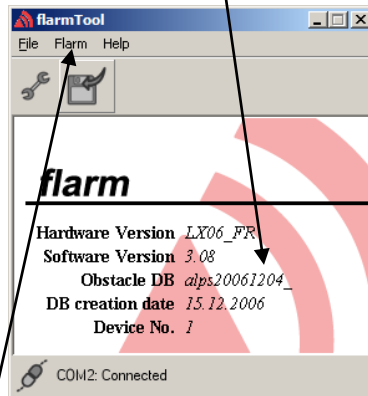

- Click on **Flarm**
- Select kind of transfer (**Recover** for firmware update)
- Follow **wizard**
- Wait until **finish**
- **Disconnect** comport
- Switch Flarm unit **off and again on**
- Provide functional **check**

LX 7007 ANALOG UNIT Wiring

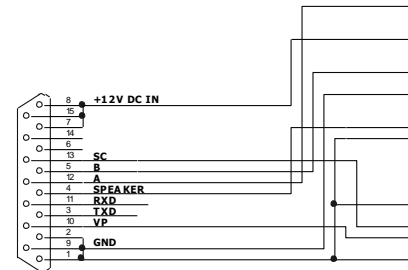

LX 7007 DIGITAL UNIT Wiring

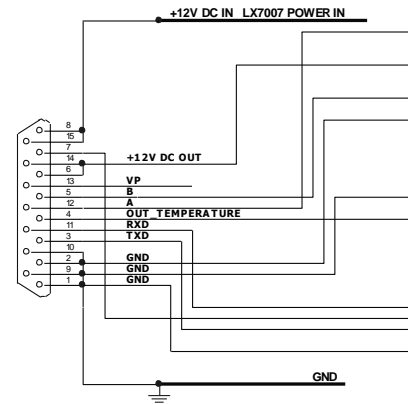

LX7COL CABLE

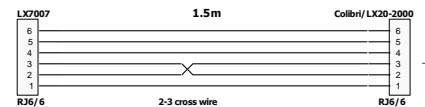

LX7000 / LX20 Communication Cable (delivery not included)

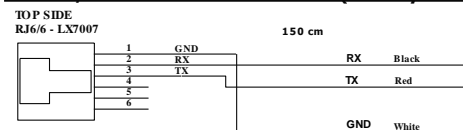

5 Installation

The Red Box may be installed wherever in the cockpit (doesn't need manipulation during flight). Respect that periodically firmware update will be requested. The display should be good insight and also available for manipulation.

5.1 Display installation

Find a convenient place in the cockpit, which offers a good viewing angle to the LED's. LX Navigation offers a small housing which will make installation on the top of the instrument panel professional.

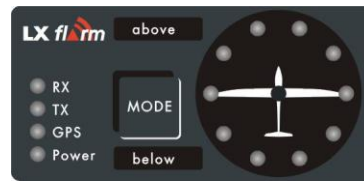

Two connection cables having different lengths are offered to ensure all possible installation solutions.

5.2 Power

Two wires coming out of the unit (red + and blue -) are used for power supply.

Note!

There is no internal fuse built in the unit. Use External fuse 1A. The unit is prevented against wrong polarity of input voltage.

The unit can also receive power via external display plug, but can not supply other units via this connector.

5.3 RF antenna installation

The RF antenna installation should be taken serious; a bad positioned antenna may reduce system parameters dramatically.

The antenna consists of three parts:

- Radiator apr. 10 cm rubber coated
- Back plane an aluminum plate having diameter 12 cm
- Cable (60 cm) with SMA connector

The radiator should be vertical and the back plane horizontal. Use top positions on the instrument panel. Having no space to install the antenna, use a dipole variant, available by LX Navigation or Flarm dealers.

 $\lambda/4$ antenna

Dipole antenna

5.4 GPS antenna installation

The GPS antenna which is a part of delivery should be installed somewhere in the cockpit where a good satellite contact can be established. Never install the antenna close to another GPS antenna. Minimum 15 cm of space diversity is required. The antenna delivered with Flarm Red box is an integral part of the system. Due to extreme small outline of the antenna (21x27 mm) the installation doesn't mean a problem. Keep **GPS marked** side up.

Note!

Flarm unit will not work until having GPS 3D, means antenna installation is an important fact.

5.5 Final check

After LX Flarm unit will receive power, the External display will pass initial routine which will take several seconds.

1. **Power red flashing**, no data from Flarm.....**ERROR***
2. **Power green** data received.....OK
3. **GPS red** GPS BAD, **GPS green** GPS OK/3D.....OK
4. **Tx green** flashing, data sent.....OK
5. **Rx green** minimum one glider received.....OK

* Mentioned error message is usually connected with **not matched** baud rate of Flarm unit and the display. By problems check Flarm unit baud rate after using of **Flarm tool** and adapt display as described in 1.3.1.

Note!

After installation obligatory check functionality from 1 to 3 and 5.

6 SD card and Flight recorder option

Note!

LX Flarm Red Box comes in two versions and both are equipped with SD card. All depends on Flight recorder graduation if IGC approved or not. A very clear mark that the unit is an IGC version is security label on the cover.

The SD card slot is connected via 50 cm flexible cable to the Flarm unit. One already formatted SD card is delivered with the unit. It is recommended to install SD card slot somewhere on the instrument panel. The functionality of SD card is as follows:

- Storing of flights
- Update of obstacle data base
- Flarm firmware update
- Update of flight recorder settings via **flarmcfg.txt** and SD card

Note!

Flarm traffic avoidance functionality does not depend on SD card status (inserted or not).

Note!

FAT 32 formatted SD cards will not be accepted by the system. Use FAT 16 formatted cards, delivery included card is already formatted and ready for operation.

All files should be **copied to the SD** card (no folders permitted), also it is not allowed to change any file name.

6.1 Firmware update after using of SD card

Ready for update procedure:

- Insert the card and switch the Flarm unit off, for minimum 5 seconds
- Power on Flarm unit

Firmware update:

- An update will follow after a file having extension **.fw** will be detected; the procedure will take approximately one minute and will run automatically.

The obstacle data base update procedure:

- If an **.obs** file type will be detected, an update will follow. The update may take **several minutes**.

Read of flight recorder data:

- The last 20 flights will be automatically copied to SD card after each power on. If some flights also exists, they will not be doubled. After a longer time flying without the card inserted the copy procedure may take some longer time because all 20 flights must be transferred to the card. To start copy to SD card remove power for apr. 5 seconds and power on again. The procedure will run automatically.

7 Limitations

Note!

Using of Flarm will **not reduce responsibility** of the pilot to monitor the airspace and to react in case of a collision risk.

See Flarm manual for details.

8 IGC approved flight reordered management

LX Flarm Red Box is offered also with “diamond level” IGC approved flight recorder. Units having this option differ against to non approved units in following:

- On the label you see a three character **IGC** designation code (for instance MR0)
- The unit is protected with one safety label against non authorized opening of the box
- The button on the top of the unit may be used as **event** marker activator

Note!

The label should remain not damaged, after damage the flight data will become invalid.

8.1 Task declaration

There are many ways to provide task declaration. The simplest way seems to be with SD card and **flarmcfg.txt** file. Immediately after Flarm will recognise mentioned file an automatic update will follow. To create files use **TOOL** available on **www.flarm.com**.

8.1.1 Task declaration via PDA/PNA

Many PDA/PNA programs are able to transfer declaration into LX Flarm RB the solution is especially practicable as Flarm is taken as GPS source for PDA/PNA.

Connection of Flarm RB to some LX navigation units for instance:

-LX 1606

-LX 166

-LX Mini Map

makes possible to transfer declaration indirect after assistance of above mentioned units.

Programs tested by LX navigation:

SeeYou Mobile, ConnectMe also via LX 166, LX 1606, LX Mini Map

8.1.2 Downloading of flights

There are two ways how to download flights.

8.1.2.1 Using of SD card

In general the flight will be copied to SD card after next power on, so it is suggested to switch the unit off after landing and to switch new one to arrange data storage to SD. It is not recommended to make many flights without SD card inserted, as in that case a long time will be necessary to download the flights. The procedure in details:

1. After landing, let the Red Box or Mini Box run for up to 5 minutes to allow it to finish writing flight data to memory2. Switch off the device
3. Insert SD card in its slot (if it is not already there)
4. Switch the Red Box on and let it run for up to 5 minutes
5. Remove the card; the flight will have been transferred from the Red Box memory to the SD card and will be available for badge claim, SeeYou flight analysis software, etc.

In the event of difficulties use Flarm Tools (www.flarm.com) to access the Flarm using a cable

8.1.2.2 Using of Flarm tool

PC, running Flarm tool and a cable set is required for data transfer LX Flarm Red Box and PC.

9 Flarm configuration



Lx Navigation d.o.o.
Tkalska 10
3000 Celje
Slovenia

www.lxnavigation.com
support@lxnavigation.si





FLARM QUICK CHECKLIST

This Quick-Checklist is intended to support your FLARM installation and commissioning activities.

In any case, also consult the Installation and Operating Manuals.

We recommended filling out this Checklist and to store it together with the official aircraft files.

Aircraft registration: Aircraft type:

FLARM serial number:

Checks done by:

Place and date: Signature:

Check the following items during installation:

- Most up-to-date **Installation Manual** consulted? *most up-to-date v3.08*
- Radio antenna** attached by tight screwing?
- Radio antenna** adequately placed?
- vertical position
- unobstructed radiation to all sides, neither metal nor carbon alongside or above
- doesn't touch cockpit canopy
- GPS antenna** plugged in?
- GPS antenna** adequately placed? Unobstructed view of the sky, neither metal nor carbon alongside or above
- Enough **spacing** between all radio and GPS antennae incl. those from other devices?
- Installation and wiring suitable even for severe **turbulence** and accelerations?
- Installation and wiring not obstructing **emergency exits**?
- No **wiring** bent or under stress?
- All **wiring** correct, and remaining wires individually insulated?
- Separate **electrical fuse / circuit breaker** installed and accessible?
- Display** visible, **sound** audible and **push button** accessible?
- Device accessible for software and obstacle-data **updates**?

Check the following items after installation:

- Most up-to-date **software-version** uploaded? *most up-to-date v3.08*
- Most up-to-date **obstacle-data** uploaded? *most up-to-date May 7, 2007*
- Device readiness** (after some minutes Power/GPS/Send diodes are continuously on)?
- No interference or adverse effects** with other essential systems, e.g. compass, radio, FADEC?
- For **tug/tow planes**: aircraft type configuration set to tug/tow plane with PC software?
- Official aircraft files** updated? (includes S/N, software-version, obstacle-data-version, aircraft type configuration, installation location device / display / GPS antenna / radio antenna / circuit breaker)
- Deadline for **mandatory software-update** noted? *currently February 2008*

Prior to each flight, always check the following items:

- Device readiness** (after some minutes Power/GPS/Send diodes are continuously on, no errors displayed)?
- Most up-to-date **Operating Manual** consulted, and manual on board? *most up-to-date v3.08*
- Select appropriate **sound volume** and **operating mode**
- Most up-to-date **software-version** uploaded? *most up-to-date v3.08*
- Most up-to-date **obstacle-data** uploaded? *most up-to-date May 7, 2007*